



HIGH TEMPERATURE CRYSTALS

High Temperature/Extensional Design

DESCRIPTION

An increasing number of applications require the use of high-temperature crystals. For these applications, Statek offers the CX1HT EXT and CX4HT EXT crystals. These crystals are designed to operate at temperatures up to 200°C, and feature an expected life in excess of 1,000 hours at these temperatures. The frequency range offered is 530 kHz to 2.1 MHz for CX1HT EXT crystals and 600 kHz to 2.5 MHz for CX4HT EXT crystals.

FEATURES

- High temperature operation up to 200°C
- High shock resistance
- Low EMI emission
- Hermetically sealed ceramic package

APPLICATIONS

Industrial

- Downhole instrumentation
- Rotary shaft sensors
- Underground boring tools

CX1HT EXT

530 kHz - 2.1 MHz



Actual Size



Top View



Side View

CX4HT EXT

600 kHz - 2.5 MHz

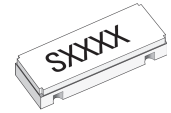

Actual Size



Top View



Side View

DIMENSIONS

DIM	CX1HT EXT MAXIMUM		CX4HT EXT MAXIMUM	
	inches	mm	inches	mm
A	0.330	8.38	0.210	5.33
B	0.155	3.94	0.085	2.16
C (SM1)	0.070	1.78	0.050	1.27
C (SM5)	0.075	1.90	0.053	1.35
D	0.055	1.40	0.046	1.16
E	0.070	1.78	0.020	0.51
F	—	—	0.025	0.64

PACKAGE DIMENSIONS

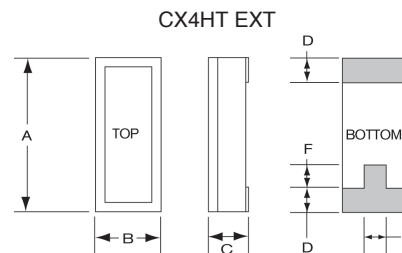
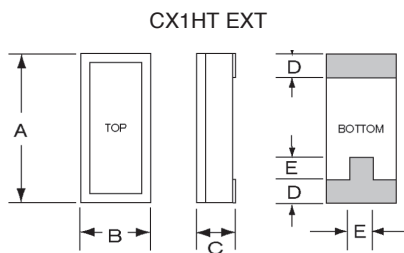

SUGGESTED LAND PATTERN

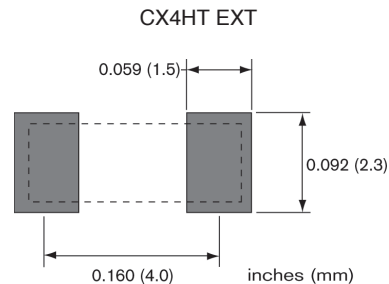
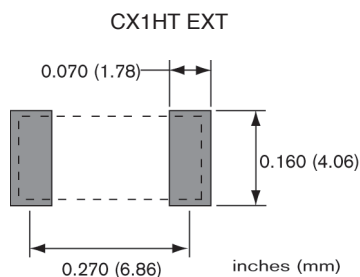

SPECIFICATIONS

Specifications are typical at 25°C unless otherwise noted.
Specifications are subject to change without notice.

Frequency Range	See Specifications Table below
Calibration Tolerance ¹	± 500 ppm (0.05%) ± 1000 ppm (0.1%) ± 10000 ppm (1.0%)
Drive Level	3 µW MAX
Load Capacitance ²	7 pF
Turning Point (T ₀) ²	35°C
Temperature Coefficient (k)	-0.035 ppm/°C ²
Note: Frequency f at temperature T is related to frequency f ₀ at turning point temperature T ₀ by:	$\frac{f-f_0}{f_0} = k(T-T_0)^2$
Function Mode	Extensional
Aging, first year	5 ppm MAX
Typical Expected Lifetime	1,000 hours @ 200°C
Shock, survival	CX1HT EXT: 750 g, 0.3 ms, 1/2 sine CX4HT EXT: 1,500 g, 0.3 ms, 1/2 sine
Vibration, survival	10 g RMS, 20-1,000 Hz random
Operating Temp. Range	-10°C to +70°C (Commercial) -40°C to +85°C (Industrial) -55°C to +125°C (Military)

1. Tighter tolerances available.
2. Other values available.

ABSOLUTE MAXIMUM RATINGS

Storage Temperature	-55°C to 125°C
Maximum Process Temperature	260°C, 20 seconds

CONVENTIONAL CMOS PIERCE OSCILLATOR CIRCUIT

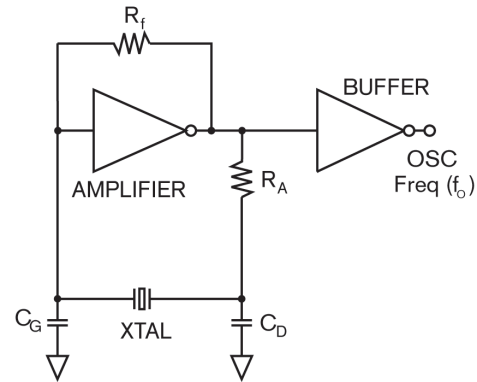

PACKAGING OPTIONS

- CX1HT EXT, CX4HT EXT
- Tray Pack
 - 16 mm tape, 7" or 13" reels
- Per EIA 481 (see Tape and Reel data sheet # 10109)

SPECIFICATIONS TABLE¹ (Specifications shown are typical unless otherwise noted.)

	Frequency Range	Motional Resistance R1 @ 25°C	Motional Capacitance C1 @ 25°C	Shunt Capacitance C0 @ 25°C	Quality Factor Q @ 25°C	Load Capacitance CL Load	Turnover Temp. (To) (°C)	Drive Level
CX1HT EXT	530 kHz to 2.1 MHz	500 Ω @ 1.0 MHz 300 Ω @ 1.8432 MHz	2.0 fF @ 1.0 MHz 2.8 fF @ 1.8432 MHz	1.1 pF @ 1.0 MHz 1.3 pF @ 1.8432 MHz	190 K @ 1.0 MHz 110 K @ 1.8432 MHz	7 pF	35°C	3 µW MAX.
CX4HT EXT	600 kHz to 2.5 MHz	300 Ω @ 600 kHz 500 Ω @ 1.8432 MHz	2.3 fF @ 32.768 kHz 1.0 fF @ 100 kHz	2.0 pF MAX.	18 K @ 32.768 kHz 31 K @ 100 kHz	9pF	35°C	3 µW MAX.

1. For more detailed specifications on low frequency crystals, refer to standard crystal datasheets (CX1 EXT and CX4 EXT.)

HOW TO ORDER CX1HT EXT and CX4HT EXT CRYSTALS

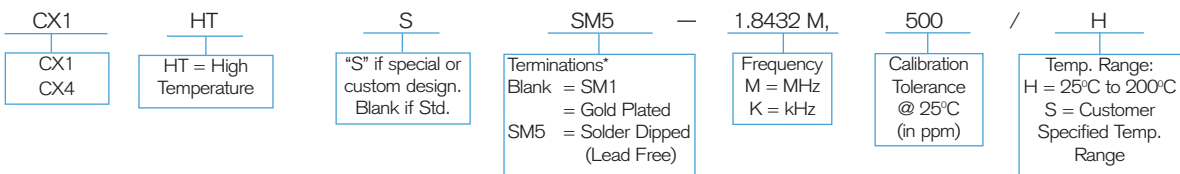

*Other terminations available. Contact factory.